

TR 8 50HP 4Pole 460v 60Hz Data Sheet

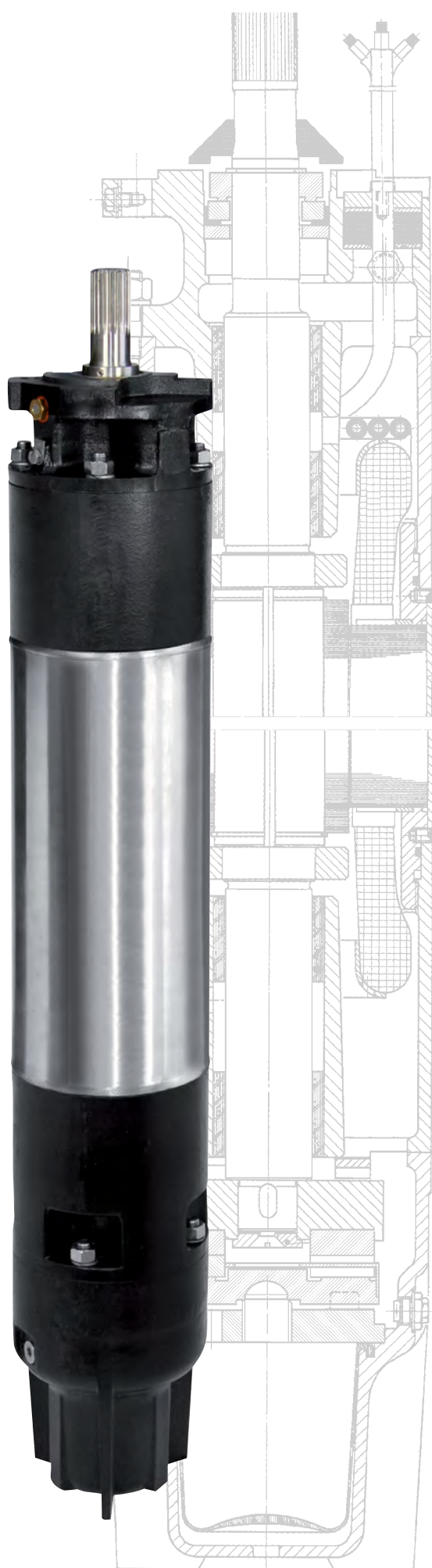

8" Asynchronous four-pole submersible motor, rewindable type, with an external shell made in AISI 316 stainless steel and supports in cast iron with paint coating (standard version). Cooling and lubrication of the thrust bearing assembly and carbon bushes is provided by a mixture of water and glycol. Squirrel-cage rotor mounted on Mitchell self-centring thrust bearing. The motor is available also in full stainless steel AISI 316 version or AISI 904 version. The USA version suitable for use with variable frequency drive (30 Hz-60 Hz). The motor is equipped with 16 feet single-core cables directly connected with the windings and it's available with DOL or STAR-DELTA starting type. The cables are certified ACS and WRAS and KTW. Overload protection must be provided by user. On request PT100 and PTC temperature sensors are available.

TECHNICAL SPECIFICATION

Flange	NEMA 8"
Degree of protection	IP58 - (IP68) optional
Cooling flow	0.5 m/s (1.64 ft/sec)
Voltage tolerance	+ 6% / -10%
Max starts	10/h
Max operating depth	300 m (984 ft)
Max operating pressure	60 bar (870 psi)
Horizontal operation	30 Hp - 125 Hp

COMPONENTES

The stator is rewindable type and it's inserted in an AISI 316 stainless steel outer shell (on request AISI 904). In the USA version the windings are made in copper PE2+PA windings for special applications such as the use with a variable frequency drive.

Mitchell type thrust bearing unit consisting of tilting pads in graphite and ceramic disc.
From 15 HP to 50 HP: 60000 N (13500lbf)
Upthrust: 12500 N (2850 lbf)

Shafts made of stainless steel with end part with key coupling. Squirrel-cage rotor made in copper. In the USA version the motor is equipped with a silicon carbide (SiC/SiC) mechanical seal. On request the motor can be equipped also with a lip seal (granting the IP 68 insulation)..

DERATING - DECLASSAMENTO - DECLASSIFICACION

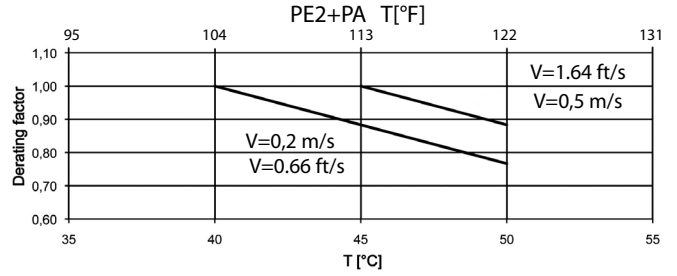
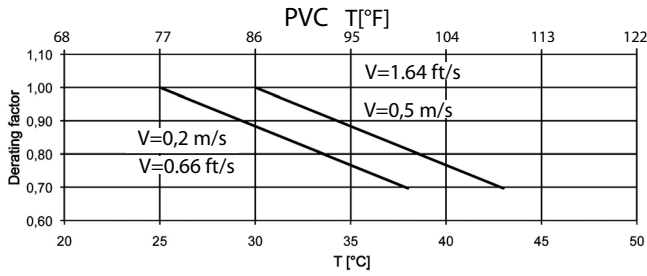

ELECTRICAL DATA 60 Hz

THREE PHASE MOTORS

4 POLE

DOL

P2	V*	In	Is/In	P1	N	Cos j	h	Ø	LC
[hp]	[kW]	[V]	[A]	[W]	[min ⁻¹]		%	[AWG]	[ft]
50	37	460	78	50655	1750	0.83	84	3x4+1x4	16

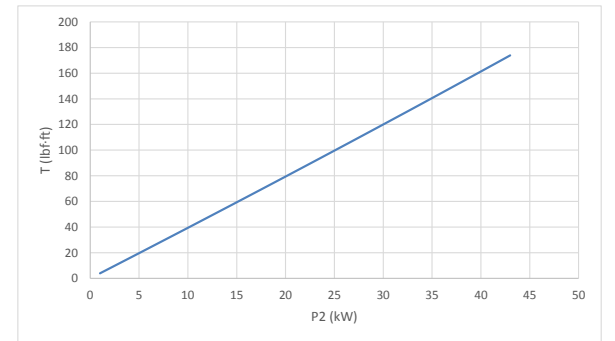
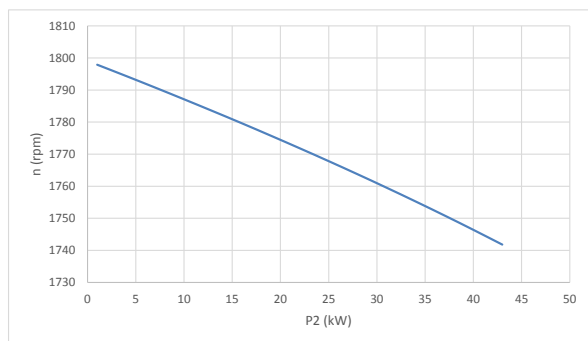
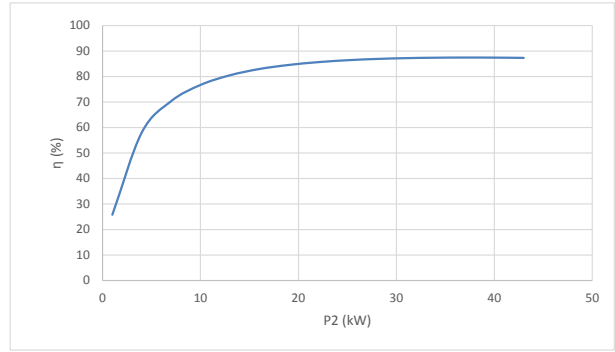
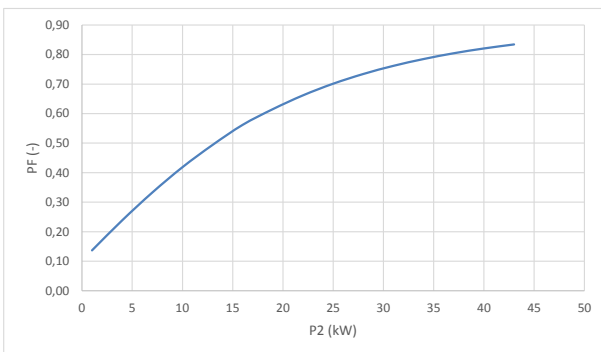
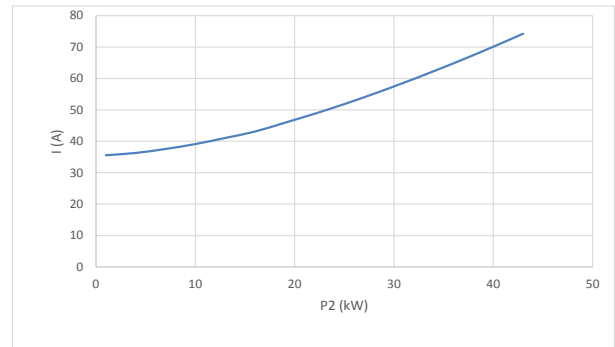
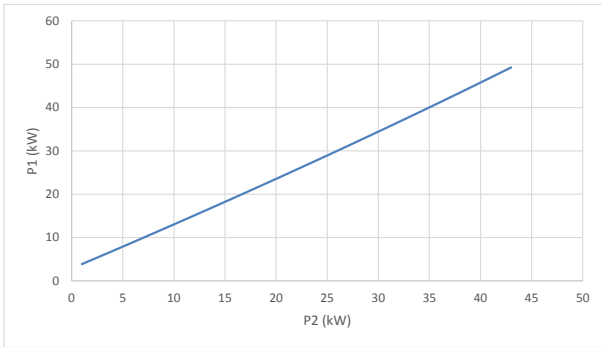

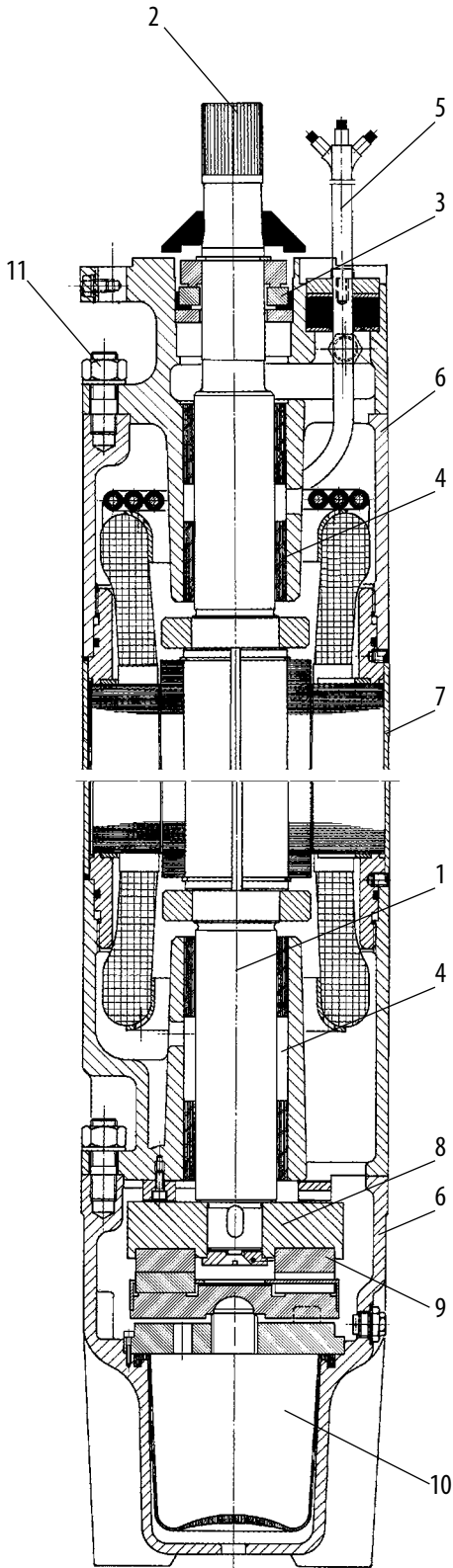

MATERIALS - MATERIALI - MATERIALES

COMPONENTS	STD version	316 SS version	904 SS version
1 Shaft	Stainless steel	Stainless steel	Stainless steel
2 Shaft end	Stainless steel AISI 316	Stainless steel AISI 316	Stainless steel AISI 904
3 Mechanical seal	Ceramic / Carbon	Sic/Sic	Sic / SiC
4 Bearing ring	Graphite	Graphite	Graphite
5 Cable	EPDM	EPDM	EPDM
6 Structural parts	Cast Iron	Stainless steel AISI 316	Stainless steel AISI 904
7 External sleeve	Stainless steel AISI 316	Stainless steel AISI 316	Stainless steel AISI 904
8 Thrust bearing rotating	Ceramic	Ceramic	Ceramic
9 Thrust bearing stationary	Graphite	Graphite	Graphite
10 Diaphragm	EPDM	EPDM	EPDM
11 Bolts & screws	Stainless steel AISI 304	Stainless steel AISI 316	Stainless steel AISI 904

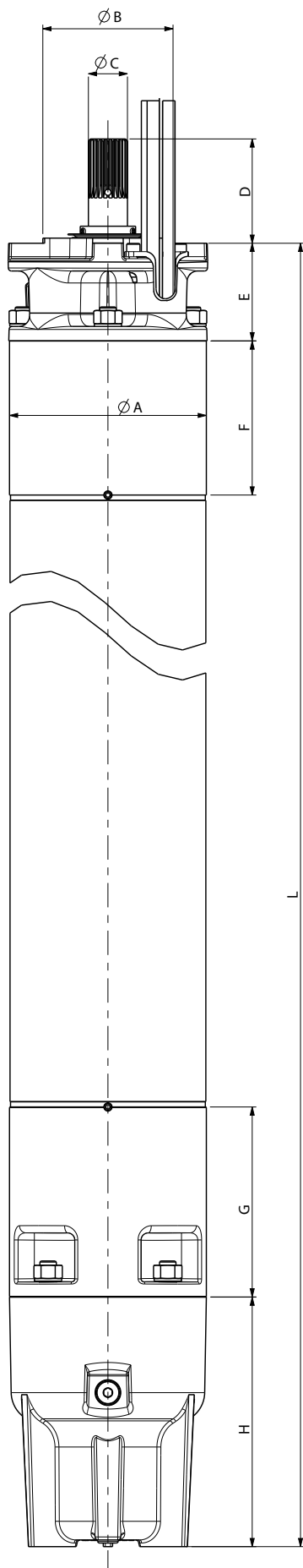

DIMENSIONS - DIMENSIONI - DIMENSIONES

THREE PHASE MOTORS - MOTORI TRIFASE - MOTORES TRIFASICOS

4POLES - 4 POLI - 4 POLOS

Type	P2		L [mm]	L [inch]	Weight		Axial thrust [lbf]
	[hp]	[kW]			[Kg]	[lbs]	
60Hz	50	37	1830	72	283	624	13500

DIMENSIONS - DIMENSIONI - DIMENSIONES

Pos.	mm	inch	Pos.	mm	inch
A	Ø 192	7.559	G	185	7.283
B	Ø 127	5"	H	243	9.567
C	Ø 38.1	1 ½"	I	4 x Ø 18	4 x 0.709"
D	101.6	4"	J	68	2.677
E	95	3.740	K	Ø 152.5	6.004
F	150	5.906			

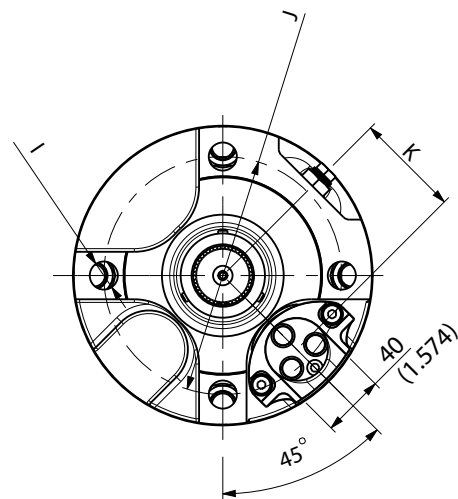

TR8
US VERSION