

# esybox MAX

LINE UP OF THE FUTURE

ELECTRONIC  
BOOSTER  
SETS

.....





# CARING FOR THE FUTURE

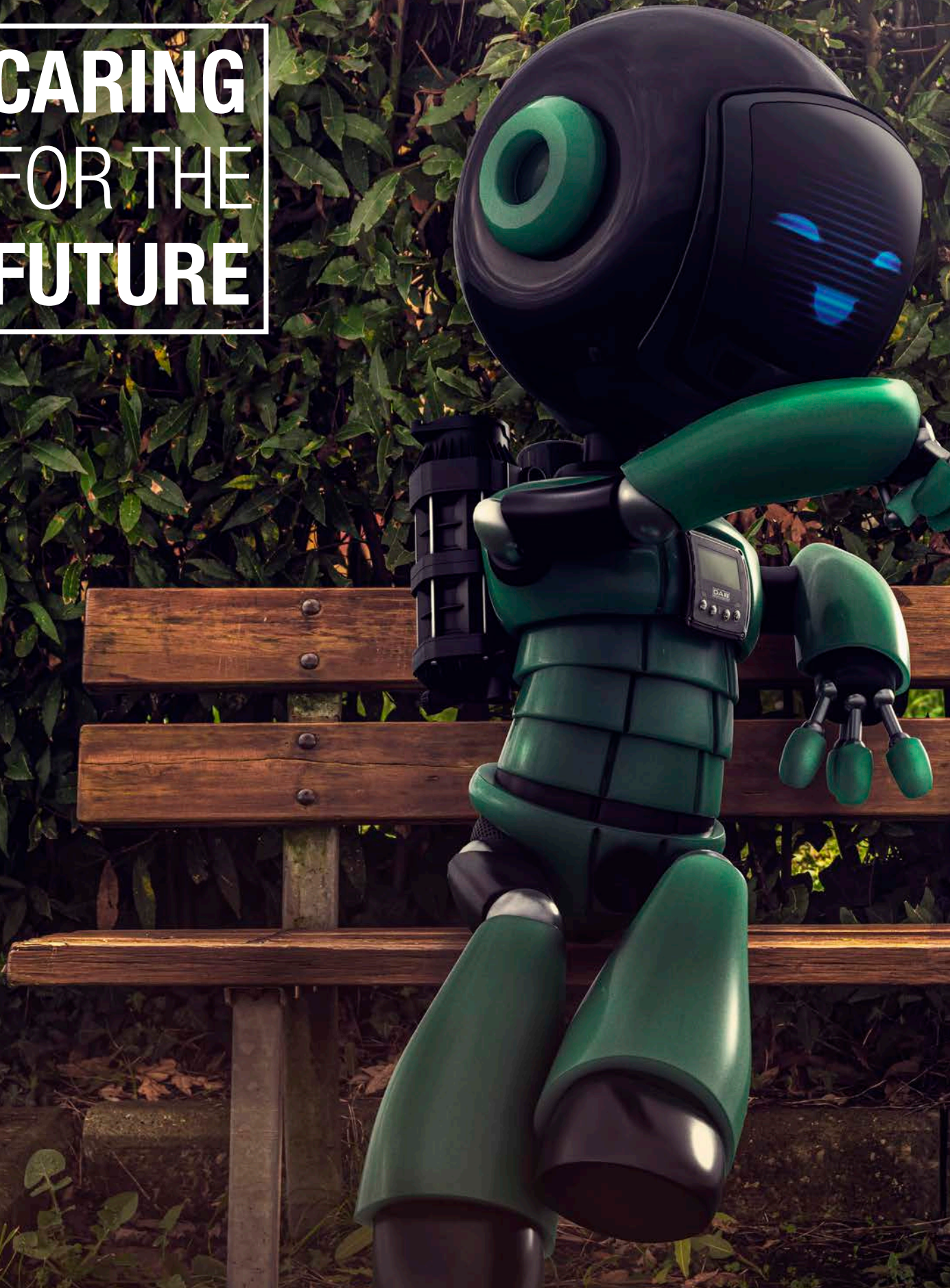

IT'S NOT JUST A MATTER OF TALKING ABOUT PERFORMANCE OR TECHNICAL FEATURES, OR EVEN STATING THAT WE ARE BETTER THAN THE COMPETITION.





WE REALLY NEED TO START FROM PEOPLE; FROM USERS. AND IF WE GIVE THEM SOMETHING THAT CAN SIMPLIFY OR IMPROVE THEIR LIVES, THEN THEY WILL BE HAPPY TO FOLLOW US.



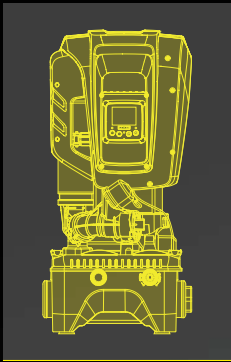

## APARTMENTS

Example: 10 floors  
20 apartments



## HOTEL

Example: 6 floors  
80 rooms

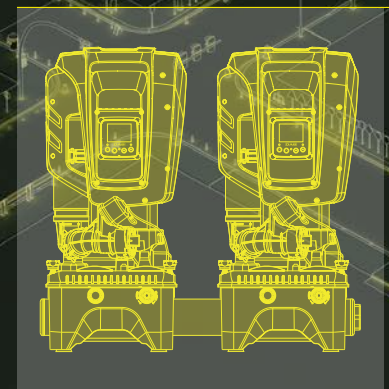

## Isn't just a great pump system

Introducing a new concept and industry first in the booster set industry





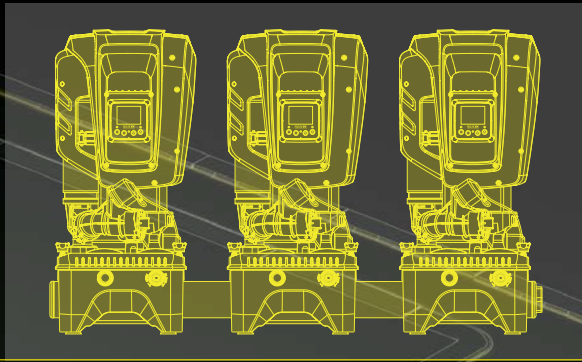

## HOSPITAL

Example: 4 floors  
100 beds

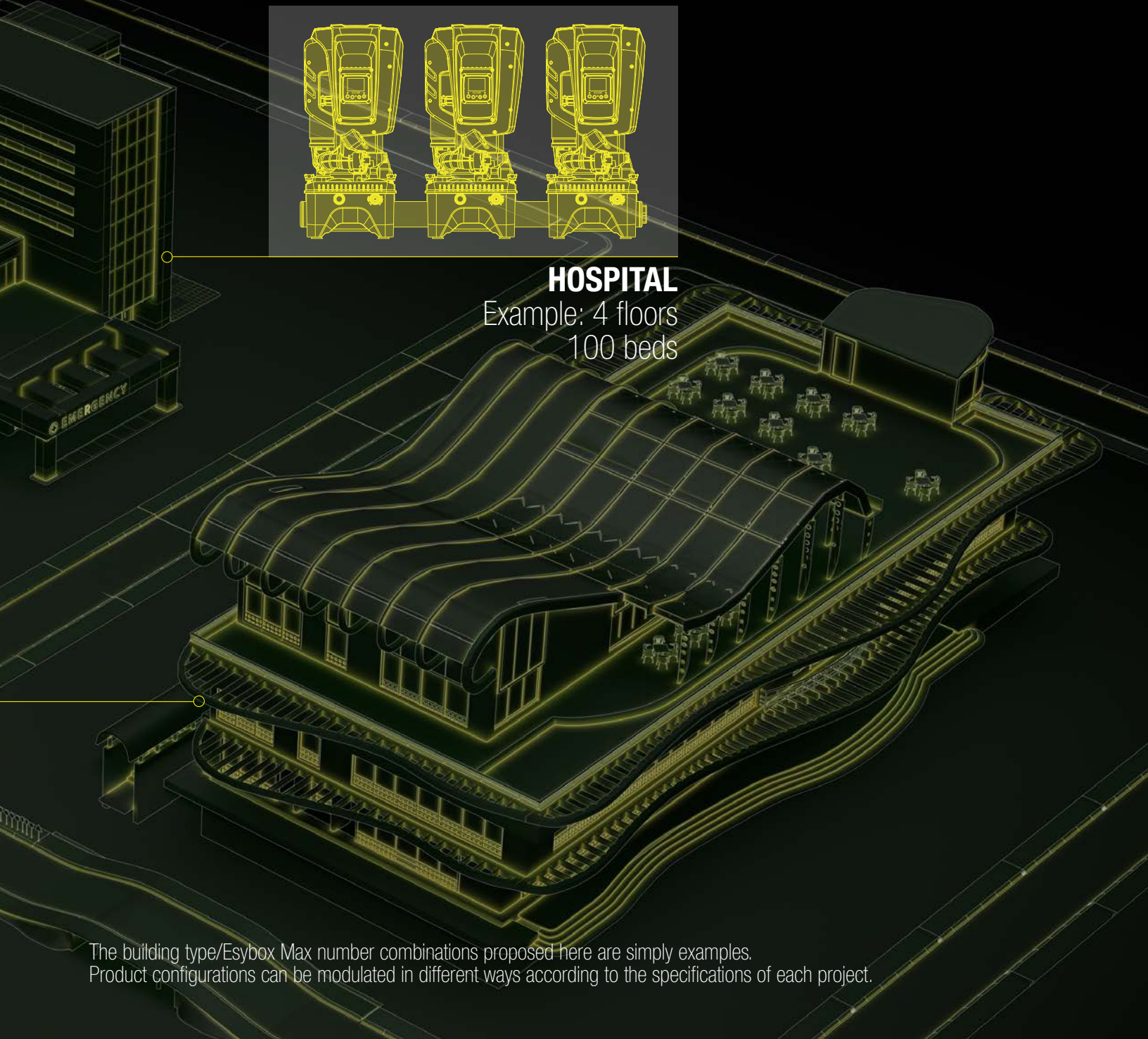

The building type/Esybox Max number combinations proposed here are simply examples. Product configurations can be modulated in different ways according to the specifications of each project.



esybox max

# The Product Journey

“Once you identify the right audience and their problems, your products come next”

**Paolo Montanari**  
Group Marketing and sales Director



## ENGINEER

“Choosing a product with the right performance for my projects often takes too much time .  
I need a solution with maximum energy efficient and with reduced dimensions compared to traditional ones. ”



## WHOLESALER

“I need to improve the efficiency of my warehouse in order to always guarantee product availability to my customers”



## INSTALLER

“I need easy-to-install products that save me time, as I often find that the plant rooms are narrow with difficult access!”

## THE VISION

"When we started to think about Esybox Max we asked ourselves how to manage the evolution of the Esybox range. It was clear from the very beginning, it could not be just something bigger.

We felt we had to bring forward the path of evolution completely changing the rules of the game for booster sets in residential & commercial buildings.

Esybox Max is the outcome of listening and communicating with many different people who will be in direct contact with the product"



### MAINTAINER

"There is a lot of talk about IOT, how can I offer a better service to my customers and introduce a new model for my business using the internet of pumps?"



### END USER

"The costs on the bill are always higher, I need reliable solutions for my system that help me to reduce my energy consumption "



### ENVIRONMENT

"It is crucial to understand that taking care of you also means taking care of our planet. Don't take our word for it, let the statistics speak for themselves"





**ENGINEER**

## Easy Selection

Understanding a new range has never been easier.

Now you only need to select from two different hydraulic models depending on the height of the building.

Then you can create your booster set, with up to four pumps, depending on the demand.

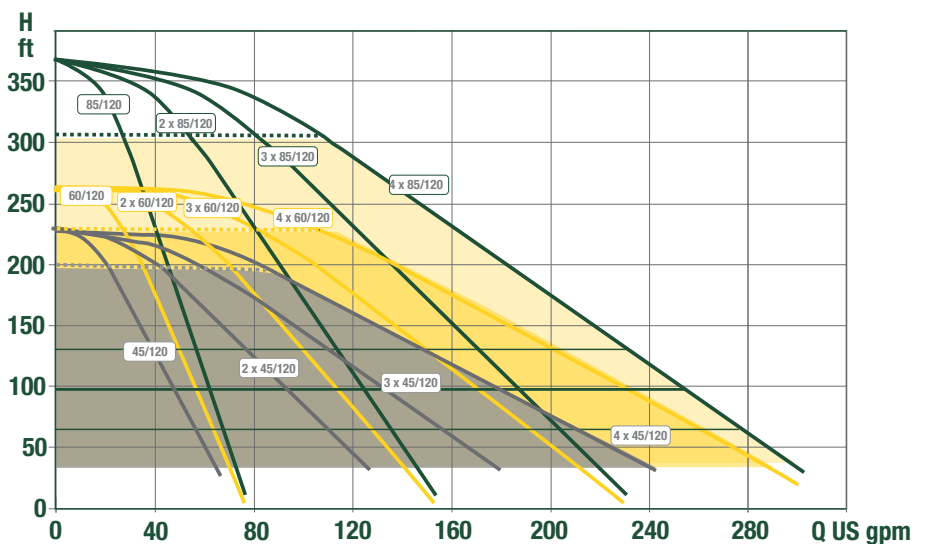



# Efficiency at the state of the art

The DAB inverter has been combined with a brand new permanent magnet motor. We also designed completely new hydraulics, making it leap ahead in terms of energy efficiency.

**BEFORE**

**AFTER**

**20%**  
Energy Saving

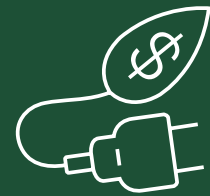

## Modular Integration

Esybox Max is the most compact and integrated booster set available on the market compared with any traditional solution.

**D**  **CONNECT**

## Affordable web based remote control for your projects

Based on state-of-the-art technology, **DConnect built-in** offers many more advantages than typical BMS systems.

Performance data storage and remote monitoring support you to control, from anywhere, that the running parameters of the pumps follow exactly to your project specification avoiding any possible site issues for complete peace of mind.





## What about logistics

Esybox Max will improve the storage efficiency in your warehouse. Where there was once one booster occupying space, you can now fit three in its place, that's three times more efficient! This allows you to store the full range on one pallet, meaning your customer can pick up an off the shelf booster solution of up to 4 pumps the same day.

That's efficient!



**WHOLESALER**



One pieces of traditional booster sets with two pumps



Six pieces of Esybox Max + three pieces of 2 Esydock Max



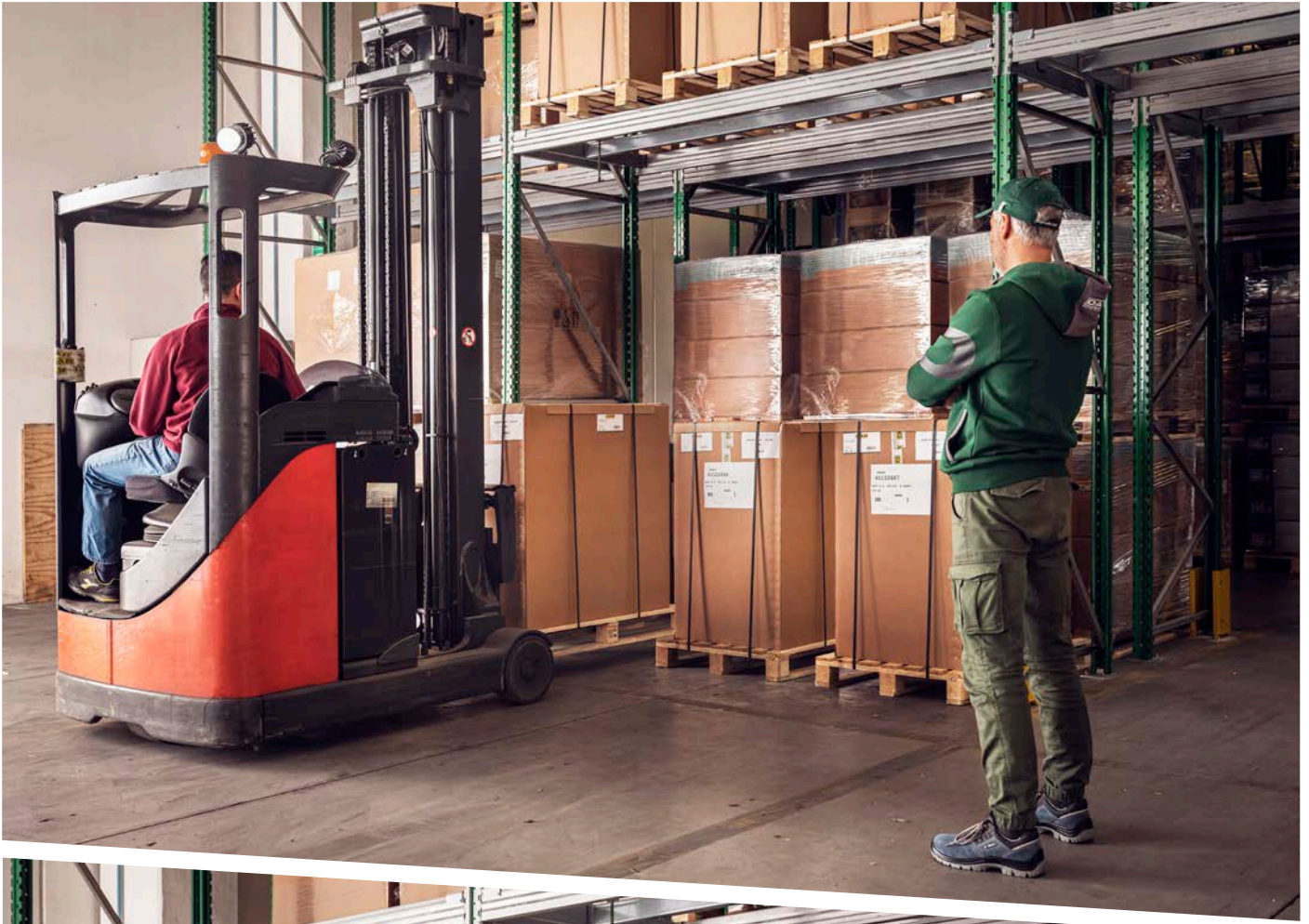





**INSTALLER**

## Easy to move & install

Keeping it flexible, we have the On-Site Assembly concept. So if you have difficulties getting to the pumps location, due to narrow stairways and corridors etc, you can choose to assemble your booster on-site which will only require moving smaller lighter boxes into the location then carry out our quick assembly steps.





# As quick as a “click”

Install Esydock into your pipework system and simply “plug” your pumps in. A final quick set up via the digital DConnect app completes your installation project.



## D+CONNECT

### Affordable web based remote control for your installation

You can use your smartphone to connect directly with the pump using the simple interface. It will automatically detect the language, time and unit of measurement at the installation site, which will save you time during the first set up of the system.

All adjustments are possible remotely allowing total control with no unwanted surprises.

DConnect makes monitoring DAB products easy and intuitive.





# Easy to maintain

Why waste your time stuck in a traffic jam getting to your customers pumps?

Now you can connect to them from anywhere.

From the coffee shop, car or the comfort of your own home, just log on through your PC or smartphone to the DConnect app. All you need to do is check the stored data and change any setting with just one click.

## MAINTAINER



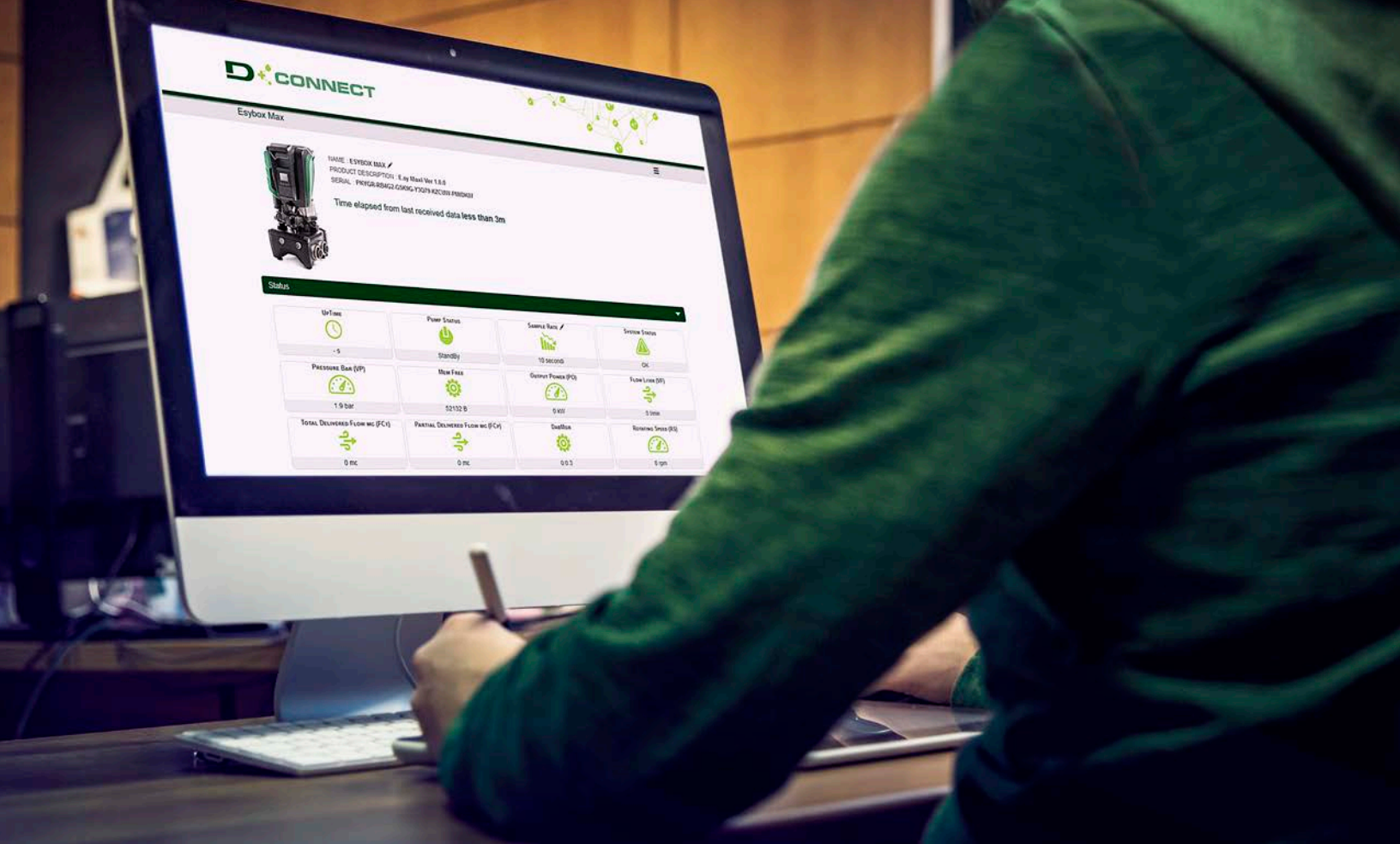

# A new boost for your business

Thanks to 'internet of pumps' technology, you will be able to monitor and control your installations receiving alarms and notifications on any possible malfunctions or issues and keeping the main operating data under control, such as energy and water consumption.

You'll experience a reduction in costs associated with on-site visits and duration of interventions, guaranteeing at the same time greater reliability of the systems.

With DConnect you can offer your customers a more effective and economical service, such as the new Silver and Gold packages, these allow basic and advanced assistance and are linked to the set up of the Esybox Max, allowing continual monitoring and remote control of the systems, connecting you in real-time to specific and settable alarms and the receiving of reports on the performance of the systems.





# Here comes the COMFORT

Energy-saving, thanks to the integrated inverter it optimises performance; comfort, thanks to the DConnect app which allows you to manage the pressure required at any given moment to enjoy, for example, a nice hot boosted shower in total relaxation.

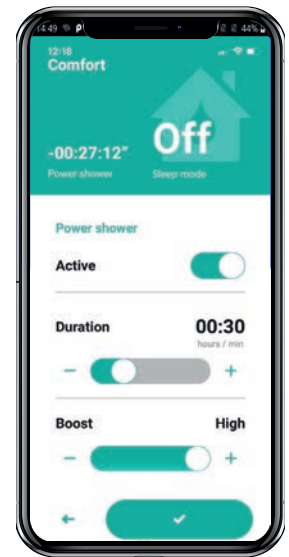

## LESS COSTS ON YOUR BILL!

VISIT OUR WEBSITE  
TO CALCULATE YOUR SAVING



END USER





## Designed for the environment

“SUSTAINABILITY, for DAB, is not just technology, it's much more..”



The Esybox Max is state-of-the-art in the field of energy efficiency



Constructed with recycled materials wherever possible



Incredibly efficient in lowering CO<sub>2</sub> emissions during transportation



# Stripped bare

With Eskybox Max the concept of integration has reached a new standard. Each new component is combined to deliver a better product/user experience.



- ① DISPLAY
- ② INVERTER
- ③ WIFI &/ BLUETOOTH MODULE
- ④ PRESSURE SENSOR (delivery side)
- ⑤ PRESSURE SENSOR (suction side)
- ⑥ NON-RETURN VALVE / CHECK VALVE
- ⑦ 0.5 GAL / 2 LT. EXPANSION TANK
- ⑧ IMPELLERS
- ⑨ HYDRAULICS CONNECTIONS
- ⑩ FAST CONNECTION TOOL
- ⑪ WATER COOLED PERMANENT MAGNET MOTOR
- ⑫ HANDLES







# The assembling technology

## ERGONOMICS

Every single operator movement has been analysed and studied to create a production line that is as safe as it is efficient.



## QUALITY

All assembly operations are performed with equipment that's monitored by a centralized control system for which the operator has all the necessary instructions immediately available on the display. After each pre-assembly phase, the various components undergo control tests (quality gates) to ensure that they work perfectly. No component proceeds to the next assembly phase if it does not pass each test.



## TRACEABILITY

The entire assembly process is optimized. All technical and historical data of the production process and the product are recorded in a unique database that can be traced at any time. The data control and the traceability system is designed to take full advantage of the potential of our Manufacturing Execution System (MES).

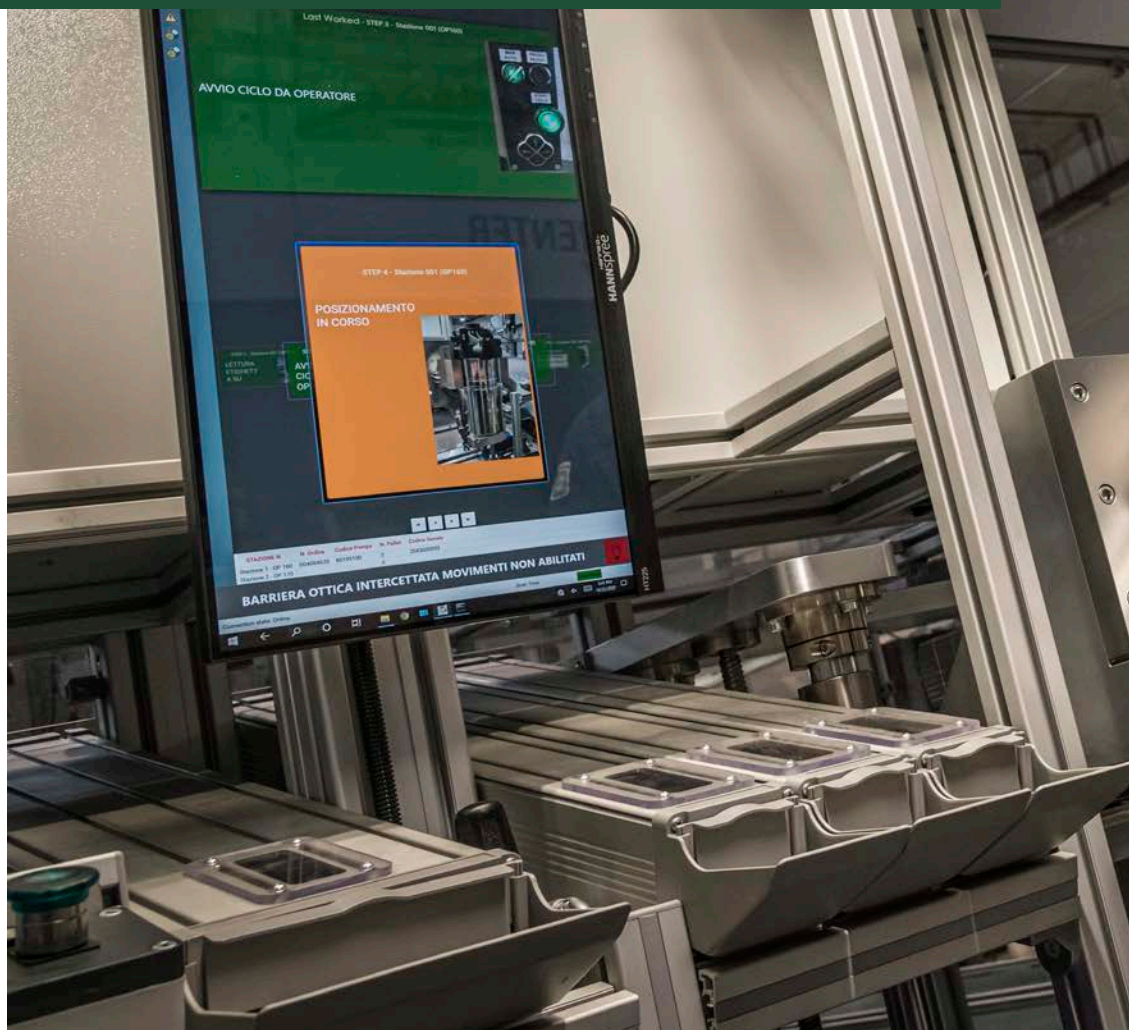



For DAB, the research and application of new technologies mean finding the best possible solution to users' needs, while fully respecting the environment.

Technological innovation is never an end in itself but functional to perfecting the quality of work and maximising product reliability.





# Technical Data

<b>FLOW RATE:</b>	Up to 76 gpm (17.4 m <sup>3</sup> /h) for a single unit
<b>HEAD:</b>	370 ft (113 m)
<b>LIQUID TEMPERATURE:</b>	122°F (+50°C)
<b>MAXIMUM AMBIENT TEMPERATURE:</b>	131°F (+55°C)
<b>MAXIMUM INLET PRESSURE:</b>	72 psi (5 bar)
<b>OPERATION PRESSURE:</b>	174 psi (12 bar / 1200 kPa)
<b>CONSTANT PRESSURE RANGE:</b>	15 - 174 psi (1-12 bar) 45 psi (3 bar) default setting
<b>MOTOR PROTECTION CLASS:</b>	IP X5
<b>MOTOR INSULATION CLASS:</b>	F
<b>IMPELLER MATERIAL:</b>	Technopolymer
<b>SINGLE PHASE POWER INPUT:</b>	208-240V 50/60Hz
<b>THREE PHASE POWER INPUT:</b>	380-480V 50/60Hz
<b>TYPE OF INSTALLATION:</b>	Fixed in vertical position
<b>TYPE OF PUMPED LIQUID:</b>	Clean, free from solid or abrasive substances, non-viscous, non-aggressive, non-crystallized and chemically neutral
<b>CERTIFICATION:</b>	to standards NSF 372, NSF61, CSA, UL

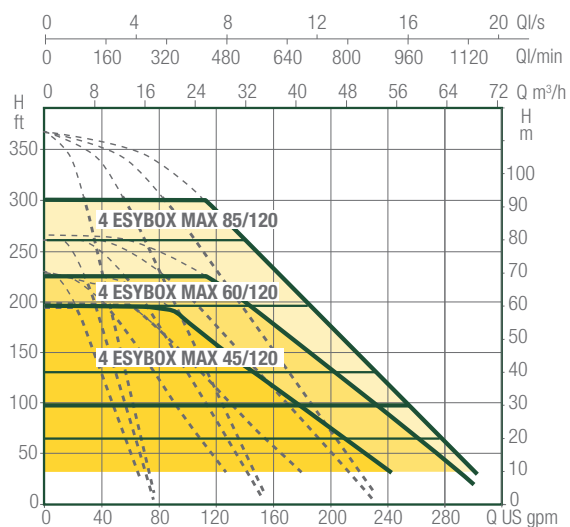
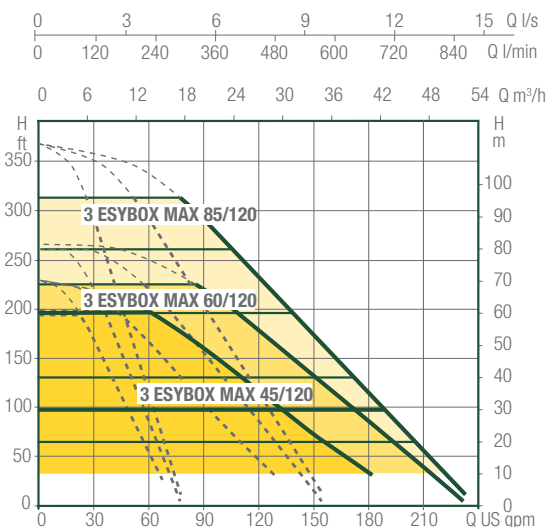
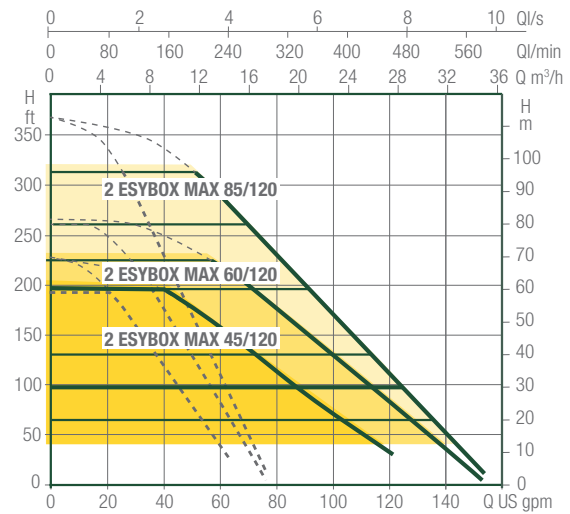
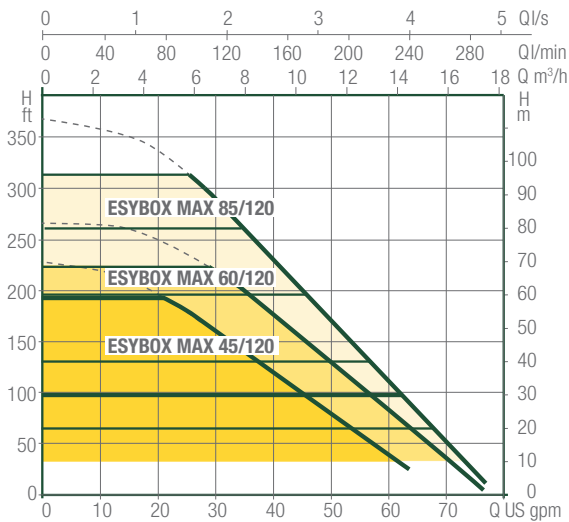

# Accessories

## ESY I/O

The electronic expansion module allows Esybox Max to interface with the external input/output devices (eg: float switch, pressure switch, remote alarm) and with the BMS world (Building Management System).



ESYBOX MAX	2 ESYBOX MAX	3 ESYBOX MAX	4 ESYBOX MAX
•	•	•	•





**DAB PUMPS LTD.**  
6 Gilberd Court  
Newcomen Way  
Severalls Business Park  
Colchester  
Essex  
CO4 9WN - UK  
salesuk@dwtgroup.com  
Tel. +44 0333 777 5010



**DAB PUMPS BV**  
'tHofveld 6 C1  
1702 Groot Bijgaarden - Belgium  
info.belgium@dwtgroup.com  
Tel. +32 2 4668353



**DAB PUMPS B.V.**  
Albert Einsteinweg, 4  
5151 DL Drunen - Nederland  
info.netherlands@dwtgroup.com  
Tel. +31 416 387280  
Fax +31 416 387299



**DAB PUMPS GMBH**  
Am Nordpark 3  
D - 41069 Mönchengladbach - Germany  
info.germany@dwtgroup.com  
Tel. +49 2161 47388-0  
Fax +49 2161 47388-36



**DAB PUMPS IBERICA S.L.**  
Calle Verano 18-20-22  
28850 - Torrejón de Ardoz - Madrid  
Spain  
Info.spain@dwtgroup.com  
Tel. +34 91 6569545  
Fax: + 34 91 6569676



**DAB PUMPS HUNGARY KFT.**  
H-8800  
Nagykanizsa, Buda Ernő u.5  
Hungary  
Tel. +36 93501700



**DAB PUMPS POLAND Sp. z o.o.**  
Ul. Janka Muzykanta 60  
02-188 Warszawa - Poland  
polska@dabpumps.com.pl



**OOO DAB PUMPS**  
Novgorodskaya str. 1, block G  
office 308, 127247, Moscow - Russia  
info.russia@dwtgroup.com  
Tel. +7 495 122 0035  
Fax +7 495 122 0036



**DAB PUMPS INC.**  
3226 Benchmark Drive  
Ladson, SC 29456 - USA  
info.usa@dwtgroup.com  
Tel. 1- 843-797-5002  
Fax 1-843-797-3366



**DAB PUMPS SOUTH AFRICA (PTY) LTD**  
Twenty One Industrial Estate,  
16 Purlin Street, Unit B, Warehouse 4  
Olifantsfontein -1666 - South Africa  
info.sa@dwtgroup.com  
Tel. +27 12 361 3997



**DAB PUMPS (QINGDAO) CO. LTD.**  
No.40 Kaituo Road, Qingdao Economic & Technological  
Development Zone  
Qingdao City, Shandong Province - China  
PC: 266500  
sales.cn@dwtgroup.com  
Tel. +86 400 186 8280  
Fax +86 53286812210



**DAB PUMPS DE MÉXICO, S.A. DE C.V.**  
Av Amsterdam 101 Local 4  
Col. Hipódromo Condesa,  
Del. Cuauhtémoc CP 06170  
Ciudad de México  
Tel. +52 55 6719 0493



**DAB PUMPS OCEANIA PTY LTD**  
426 South Gippsland Hwy,  
Dandenong South VIC 3175 - Australia  
info.oceania@dwtgroup.com  
Tel. +61 1300 373 677



**PT DAB PUMPS INDONESIA**  
Satrio Tower lantai 26  
unit C-D, Jl. Prof. Dr. Satrio Kav. C4,  
Kel. Kuningan Timur, Kec. Setiabudi, Kota Adm.  
Jakarta Selatan, Prov. DKI Jakarta. - Indonesia  
Tel. +62 2129222850